

# HSF

NOTES:  
 Rated Current: 9.0AMP  
 Contact Resistance: 30mΩ max  
 Withstand Voltage: 1500V AC/minute  
 Insulation Resistance: 1000MΩ min  
 Operation Temperature: -25°C to +85°C

Contact Material: Brass  
 Contact Plating: Au Or Sn Over Ni  
 Insulator Material: PA66 Or PA46

Recommended P.C.B Layout(Top Side)  
 (PCB BOARD TOLERANCE±0.05)

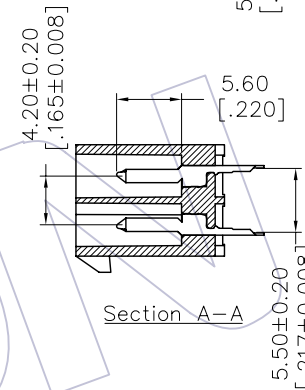
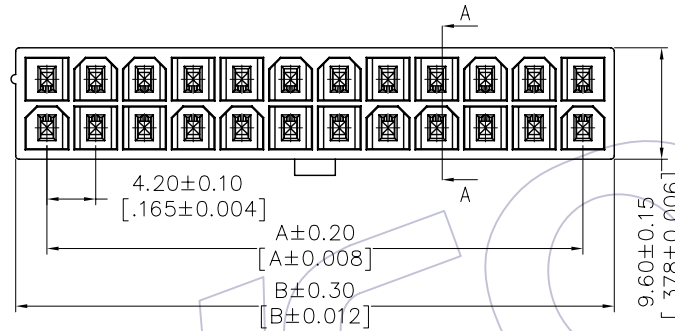
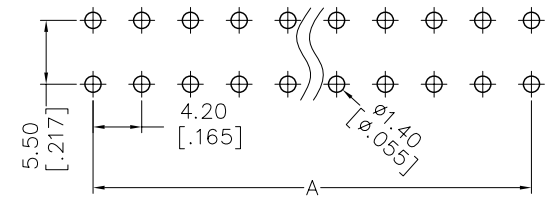

## Ordering Information

WF4201 -2WS XX W 0 1

No. of Row Dual Row  
 No. of pins 01-12P  
 Contact Plating  
 S0=Gold Flash/Tin  
 S3=10u"Gold/Tin  
 S4=15u"Gold/Tin  
 S5=30u"Gold/Tin  
 G0=Gold Flash  
 G3=10u"Gold  
 G4=15u"Gold  
 G5=30u"Gold  
 Blank=Tin  
 Insulation Material  
 H=PA46  
 Blank=PA66  
 Color  
 B=Black  
 W=White  
 Packing  
 0=PE Bag

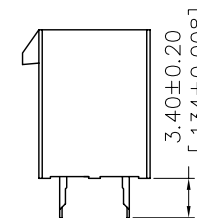
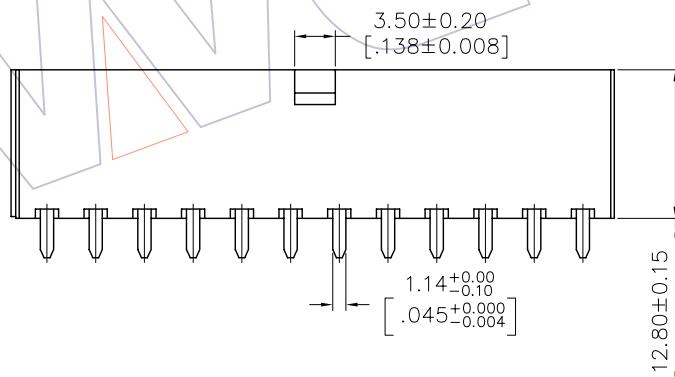

## Dimensional & Ordering Information

Circuit	Part No.	Dimension	
		A	B
2x01	WF4201-2WS01W01	---	5.40
2x02	WF4201-2WS02W01	4.20	9.60
2x03	WF4201-2WS03W01	8.40	13.80
2x04	WF4201-2WS04W01	12.60	18.00
2x05	WF4201-2WS05W01	16.80	22.20
2x06	WF4201-2WS06W01	21.00	26.40
2x07	WF4201-2WS07W01	25.20	30.60
2x08	WF4201-2WS08W01	29.40	34.80
2x09	WF4201-2WS09W01	33.60	39.00
2x10	WF4201-2WS10W01	37.80	43.20
2x11	WF4201-2WS11W01	42.00	47.40
2x12	WF4201-2WS12W01	46.20	51.60

REV	DATE	MODIFICATION DESCRIPTION	CHANGE	OPERATION		DRAW	DATE	SCALE	FIT	PART NO.
				X.X	±0.40					
				X.XX	±0.25	CHECK	DATE	SIZE	A4	TITLE: 4.20 MINI FIT DUAL ROW 180° WITH SHORT BUMP WITHOUT POST
				X.XXX	±0.15	APPROVE	DATE	SHEET	1/2	Customer NO.
				Angle	± 3'			PROJ.		
				DIM	TOL					

**WCON**  
 Http: www.wcon.com

WCON-Dongguan  
 Tel: +86 769 85358920  
 Fax: +86 769 85358915  
 E-mail: sales@wcon.com

WCON-Kunshan  
 Tel: +86 512 57468408  
 Fax: +86 512 57468468  
 E-mail: salesks@wcon.com

# HSF

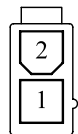

2x01P

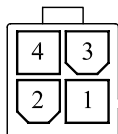

2x02P

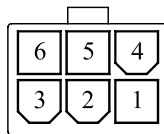

2x03P

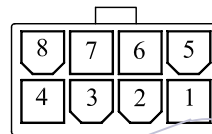

2x04P

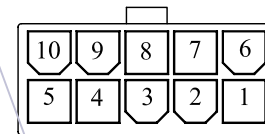

2x05P

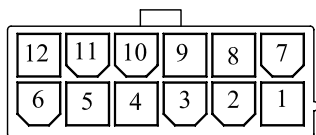

2x06P

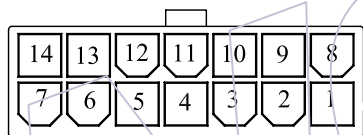

2x07P

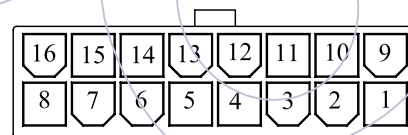

2x08P

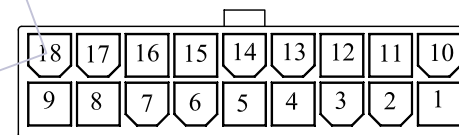

2x09P

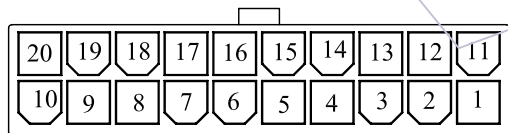

2x10P

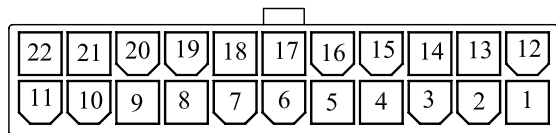

2x11P

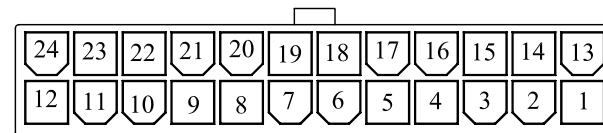

2x12P

				OPERATION	DRAW	DATE	SCALE	FIT	PART NO.	 <a href="http://www.wcon.com">Http: www.wcon.com</a> WCON-Dongguan Tel: +86 769 85358920 WCON-Kunshan Tel: +86 512 57468408 Fax: +86 769 85358915 Fax: +86 512 57468468 E-mail: sales@wcon.com E-mail: salesks@wcon.com
				x.x ±0.40	JYHuang	2012/09/17	UNIT	mm	WF4201-2WSXXW01	
				x.xx ±0.25	CHECK	DATE	SIZE	A4	TITLE:	
AO	2012/09/17	NEW		x.xxx ±0.15	APPROVE	DATE	SHEET	2/2	4.20 MINI FIT DUAL ROW 180° WITH SHORT BUMP WITHOUT POST	
REV	DATE	MODIFICATION DESCRIPTION	CHANGE	Angle ± 3°			PROJ.	☉	Customer NO.	
				DIM TOL						